

LOEVSCHALL

THE GOOD LIGHT

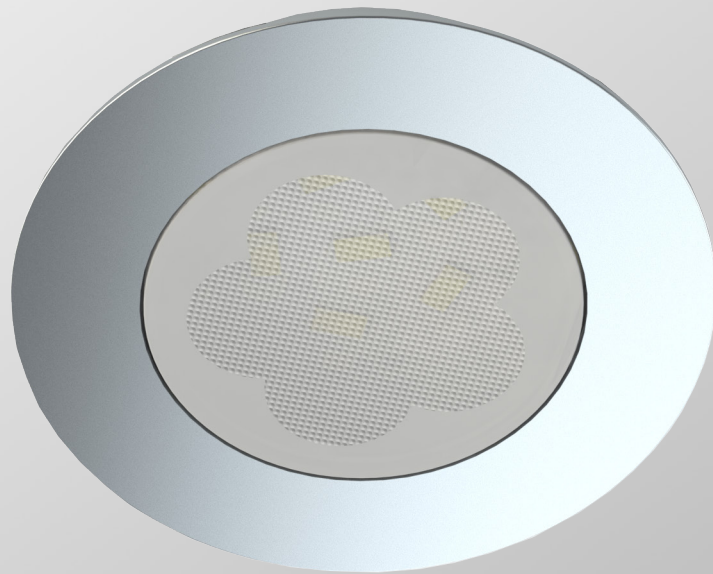
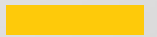

Brilliant LED spot 350mA

Niedriger Energieverbrauch

Optimale Lichtqualität und Farbe

Einfache Installation



Brilliant LED spot

Artikelnummer: 3470200055

ALLGEMEINE EIGENSCHAFTEN

Stromversorgung	350mA
Lichtquelle.....	LED
Leistung.....	2,5 W
Kabel	2,0 m
Verpackungsmethode	Bulk

BELEUCHTUNG

Strahlwinkel	50°
Farbtemperatur	2807-3073 K
Farbwiedergabeindex[Ra].....	>95

SICHERHEIT

IP Klasse	IP44
Schutzklasse.....	III
Prüfung	CE

MATERIAL

Gehäuse.....	PA66
Linse.....	PC
Abdeckung.....	Aluminum

VERPACKUNG

Äußere Box Größe	540x260x280 mm
Äußere Box Menge.....	100 Stück
Äußere Box Gewicht	G.W.: 7,46 KGS/N.W.: 5,95 KGS

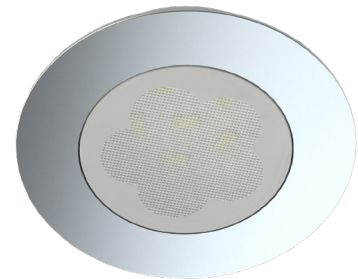
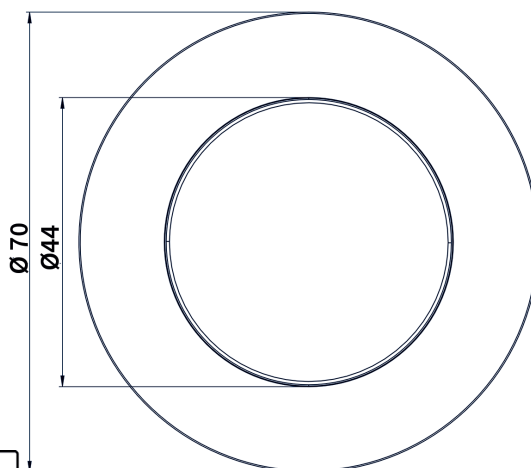
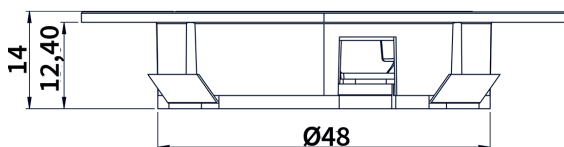

LOEVSCHALL
THE GOOD LIGHT
Brilliant LED spot

 Diese Leuchte ist verkauft mit eingebauten LED-Birnen.

 } LED

Die Lichtquellen in dieser Lampe können nicht ersetzt werden.

874/2012 

LOEVSCHALL
THE GOOD LIGHT

Nikkelvej 11
8940 Randers SV
Dänemark

loevschall@loevschall.dk
www.loevschall.dk
Tlf: +45 87 11 40 50